

## Series e<sup>3</sup>-4/e<sup>3</sup>-6 Instant Hot Water Recirculating Systems



### Installation, Operation and Service Instructions

**INSTALLER: PLEASE LEAVE THIS MANUAL FOR THE OWNER'S USE.**

**NOTE:** Bell & Gossett recommends Bronze or Stainless Steel Booster Pumps be used for pumping potable water.



**WARNING:** Before Installing, using or servicing this product, read the instructions. To reduce risk of electrical shock see instructions for proper installation.



**CAUTION:** For supply connections use wire suitable for at least 105°C. Use copper conductors only. Employer des fils d'alimentation adéquats pour 105°C. For indoor use only. Employer uniquement à l'intérieur.



**WARNING:** Risk of electric shock; this pump has not been investigated for use in swimming pool and marine areas. - **Non submersible Pump** -

#### About Recirculation Systems

##### Air in the System

A properly installed system should include a method of automatically venting the air that enters the water supply line during use. Air enters the system each time fresh, cold water is introduced into the hot water heater. Air may also enter the system any time a plumbing line is opened, for instance during a faucet/taps change or adding a sprinkler system.

##### Water Pressure

A recirculating system is a pressurized system operating at the city water pressure, as determined by the pressure regulator on your line, or by a well pump, if you are on a well system. In most residential plumbing systems, water pressure is set at 35 psi (241 kpa) and above. Below 35 psi (241 kpa), water pressure may not be sufficient to fill the pipe diameter, leaving space for air to accumulate in the lines. If your system pressure is less than 35 psi (241 kpa), use the next larger pump on the Pump Selection Guide.

##### Multiple Floors

Because the system is pressurized, the number of floors in a home is not taken into consideration in sizing the circulating pump. The pump has only to produce continuous flow at a pressure sufficient to overcome the friction losses created by the piping in the house water supply line and the return line.

##### Oversized Pumps

Pumps should not be so large as to produce flow rates that may eventually erode holes in the pipes. According to the Copper Development Association, excessive erosion occurs at a velocity of about 5ft. (1.5m) per second and higher; or about 4 GPM (15 LPM) in 1/2" (5/8") Type M copper pipe; and 8 GPM (30 LPM) in 3/4" pipe. Use the recommended recirculation line size shown in the Pump Selection Guide. Bell & Gossett pumps are sized so that flow velocities are well below these limits.

## Pump Selection Guide

The B&G e<sup>3</sup>- 4 Series models are designed to handle the recirculation requirements of residences with a pipe loop (the total length of hot water supply line plus the recirculation line) up to 250 ft (76 M). The e<sup>3</sup>- 6 Series model pump is designed to handle the circulation requirements of residences and small apartment complexes with pipe loop runs to 700 or 1000 ft. (213-304 M). The figures below provide a simple rule of thumb to help you match the pump to your system.

## Installation and Start Up

1. Select the sink under which to connect the recirculation line (the sink where the hot water takes longest to arrive which is usually the sink farthest from the water heater).
2. Plan your installation.

Decide on the course of the recirculation pipe (also determining the length of the pipe required) and whether the return line should be connected to the water heater cold water inlet line (tee fitting required) or to the bottom water heater drain valve ("Y" type fitting required to fit to existing drain valve outlet). See figure 1 and 2 for the installation schematic.



**CAUTION:** The use of fluoropolymer impregnated pipe compound and fluoropolymer tape on pipe threads provides lubricity which can lead to overtightening and breakage. Do not overtighten. Failure to follow this instruction can result in moderate personal injury from hot water and/or property damage.



**CAUTION:** Make sure the power is turned off before placing anything inside the discharge opening to move the impeller. Failure to follow these instructions could result in serious personal injury, death and/or property damage.



**WARNING:** - **Electrical Shock Hazard** - Disconnect and lock out the power before making electrical connections. Failure to follow these instructions could result in serious personal injury or death.



**WARNING:** - **Hot Water Leakage Hazard** - Pressurize the body slowly while checking for leaks at all joints with gaskets or solder connections. Failure to follow these instructions could result in serious personal injury and/or property damage.

## BU Models

- A. Return into Cold Water Line at Top of Water Heater fig. 1

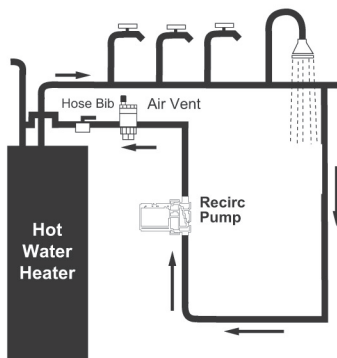

- B. Return to Drain Valve at Bottom of Water Heater fig. 2

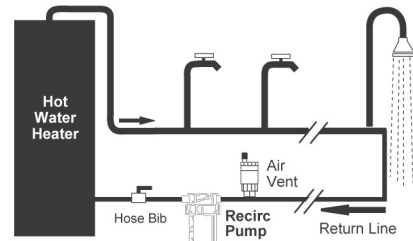

## BS Models

- A. Return into Cold Water Line at Top of Water Heater fig. 3

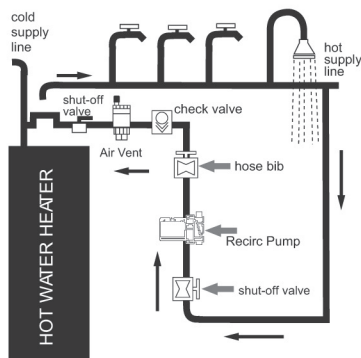

- B. Return to Drain Valve at Bottom of Water Heater fig. 4

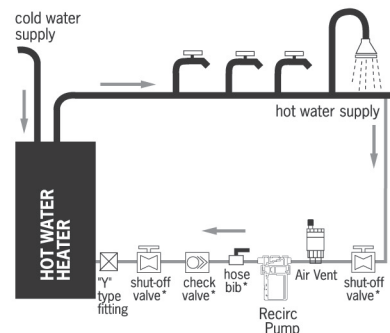

Figures on the second page are for single line returns only. For multiple branched supply line installations, a recirculation line should be installed for each branch.

**Note: The Air Vent and Hose Bib are not required with BU models. These models have a built-in air purge valve.**

**Note: The pump must always be installed below the water level of water heater so that the pump flow is always upward or directly horizontal and not downward. Do not mount the pump above the water heater.**

### 3. Wiring Instructions



**WARNING: - Electrical Shock Hazard -** Disconnect and lock out the power before making electrical connections. Failure to follow these instructions could result in serious personal injury or death.

- A. Remove the screw at the rear of the motor housing. Remove the wiring compartment cover.
- B. Attach the appropriate size electrical connector to the hole in the side of the motor housing.
- C. Using a minimum size of 14 AWG copper electrical wire (refer to your local code for wiring restrictions), wire the motor to a single phase power source that matches the electrical rating on the pump nameplate. See fig. 4. Use the size of electrical wire as dictated by code.
- D. Connect a green ground wire at least the size of the power conductors to the ground terminal.
- E. Electrical supply and ground wires must be suitable for at least 105 deg C.
- F. B&G circulators are thermally protected and do not require external overload protection.
- G. If a remote device such as a thermostat/aquastat is connected to the pump it must be wired in series with the power conductor.



**WARNING: - Electrical Shock Hazard -** Be certain that all connections are secure and the conduit box cover is closed before electrical power is connected. Failure to follow these instructions could result in serious personal injury, death and/or property damage.

Fig. 4

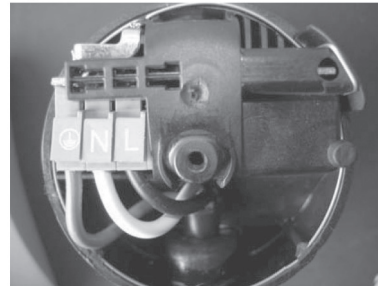

### 4. Purchase materials required

- B&G e<sup>3</sup>-4/e<sup>3</sup>-6
- Copper pipe or tubing
- Tee for under sink connect
- Tee or "Y" fitting connection to water heater
- (2) 1/2" (5/8") or 3/4" shut-off valves (not required on BU models)
- (1) 1/2" (5/8") or 3/4" swing check valve (not required on BU models)
- (1) 1/2" (5/8") or 3/4" hose bib/connection (not required on BU models)
- (1) Auto air vent (not required on BCU models)
- Misc. nipples and fittings
- Pipe insulation

### 5. Shut off the water to the house.

### 6. Drain the plumbing lines by opening the faucet/tap in the house.

Drain the water heater if you plan to make the connection at the bottom of the water heater, which requires removal of the drain valve.

### 7. Connect the return line at the last faucet/taps riser and run to the water heater.

Tee the return line as close to the end of the hot water supply line as possible and run the return line back to the water heater.

### 8. Install the pump and other components required in accordance with the diagrams provided in fig. 1 or 2 and connect the return line to the water heater.

Unscrew the pump housing from the motor (fig. 5) and run the pump for a few seconds to make sure it is operational. Remove the rotor (see fig. 6) and add a little water to the bearing ball for lubrication. Do not use grease or oil to lubricate the pump.

### Ultracirc Models

The BU models incorporate a shut off valve, check valve, and bleed valve into the brass pump housing eliminating the need to install these components. These models are supplied with 1/2" (5/8") union fittings. These fittings should be removed from the pump housing before soldering to avoid damaging the internal valves.



Fig. 5

Remove the motor unit and o-ring from the pump housing into the plumbing line. Do not sweat the housing into the plumbing line with the motor or o-ring attached. Arrows on the pump housing indicate the direction of water flow.

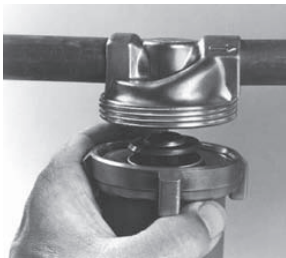

**Caution:** Only hand tighten the screw ring. Do not over tighten! Do not use plumbers putty on the screw ring.

Fig. 6

**e<sup>3</sup>-4 and e<sup>3</sup>-6 Models - Rotor/Impeller Installation:** To remove the rotor unit, grasp the top of the unit and gently pull straight up. Do not pull up on one side only or push the rotor sideways. If the rotor sits too tightly, carefully lever it off with a screwdriver on each side of the rotor. When re-installing the rotor, use enough force to hear the rotor "click" on to the ceramic bearing and spin the rotor with your fingers to insure that it turns freely.

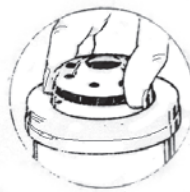

Remove the Rotor/Impeller by using forefinger and thumb and pulling upward.

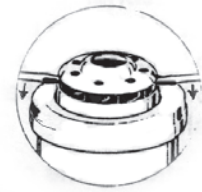

Or, if the Rotor/Impeller cannot be removed using forefinger and thumb, carefully lever off evenly with two screwdrivers.

**8. Close the shut-off valve on the inlet side of the pump and turn the water supply to the house back on.**

**9. Flush system of debris.**

Before reattaching the pump motor, open the shut-off valve on the inlet side of the pump housing and let water flow through the housing. Use a bucket to catch the water. Let the water run long enough to clear all sand, solder pellets, plumbers tape flakes, etc. from the lines. Close the inlet shut-off valve when finished.

**10. Connect the pump motor to the housing.**

Make sure the rubber o-ring is in place in the housing and the screw ring is securely hand tightened. Reopen the shut-off valve or valves and let the water flood the pump housing.

**11. Purge air from the supply line.**

Turn on the faucet/taps or shower farthest from the water heater. Open the line until you get a good, steady stream of water without sputter or evidence of air.

**12. Purge air from the return line.**

Connect the pump to the electrical supply. With the pump running, open the hose bib/connection and let water run until the pump is running quietly and there is no sputtering or other evidence of air coming from the hose bib. Close the hose bib. Your system is now in operation. Allow a few minutes for instant hot water to recirculate to all of your faucet/taps.

Correct Installation



Improper Installation -

Do NOT mount in these orientations

**Do's and Do Not's**

**Do:**

- Install an air vent mounted in a vertical position (if provided).
- Use 1/2"(5/8") recirculation line tubing.
- Check to be sure there are no crimps or sharp bends in the recirculation line that would restrict the flow.
- Be sure the check valve is installed in the proper direction of the flow.
- Be sure all air is purged from the system prior to starting the pump.
- Use a water conditioner if you have hard water.
- Be sure the gate valves are open before turning on the pump.
- Install the pump pumping in upward direction only.

**Do Not**

- Use grease or oil to lubricate the pump (it is self-lubricating).
- Over tighten the screw ring.
- Install the pump with the motor above the pump housing.
- Install the pump pumping away from the water heater nor pumping downward.
- Start the pump before the system is full of water and purged of air.
- Allow the water heater temperature above 140°F (60°C). (only in the US)
- Install the pump in the supply line to faucet/taps.
- Use any pipe size other than 1/2"(5/8") for all models.
- Position the pump at the top of the water heater.

**Note: Keep The Hot Water Temperature Below 140°F (60°C). Higher temperatures can cause calcium and magnesium elements to come out of solution and create solids which could not only cause damage to the pump but also reduce water heater efficiency and premature failure of the water heater.**

**Hard Water Conditions**

Use a water conditioner. Hard water can cause scale build-up and eventually reduce the life of the pump and other system components.

**Protected by one or more of the following Patents: 4580335, 4615662, 4822256, 4834628, 5094593, 5143049, 5749715, 6149407, 6227235**

## System Maintenance

- Do not attempt to lubricate the pump. The pump is self-lubricating.
- Prevent the pump from running dry.
- Flush the system of any debris and re-purge all air from the system in the event of any water supply interruptions in plumbing line.
- Prevent heavy scale build-up by keeping the hot water temperature 140°F (60°C) or less. (only in US)
- Don't over salt your water conditioner.

### U.L. Caution

**This pump has been tested using water only.  
Its suitability for use with liquids other than water is the end user's responsibility.**

### Australia

**This pump must be installed in accordance with AS3500**

## Trouble Shooting

### Noise in the System

The pump should be virtually noiseless during operation. The rotor may make a brief but hardly perceptible fluttering noise immediately after the pump is turned off. During normal operation, an occasional air bubble may pass through the pump housing causing a momentary gurgling noise. However, if noise at the pump persists for any prolonged period, correct the problem.

- The check valve/non-return valve is mistakenly installed on the inlet side of pump or in the wrong direction.
- The inlet side shut-off valve is closed or clogged.
- There is air trapped in the pump housing (turn the pump on and off several times to see if the air pocket can be "bumped" out of the pump and if not, then open the hose bib for manual venting).
- There is debris blocking the rotor.
- The rotor bearing has worn due to dry running causing the rotor to wobble during operation.
- If the return line connects to the cold water supply at the top of water heater, the warm water may be creating back pressure in the cold supply line. If so, add a check valve/non-return valve on the cold supply line above the return line tee connector.

### Pump Operating Intermittently or Not at All

- No power to the pump.
- There is debris or foreign matter in the pump.
- The thermostat is not functioning properly. If wanted, the thermostat may be easily disconnected. Contact the B&G factory or local representative for details.

### Water Taking Too Long to Get to Faucet/Tap

- The hot water supply from the water heater is exhausted.
- The faucet/tap involved may be on a branch line off the main hot water supply line in which case there may be a slightly longer wait for hot water to arrive than at faucet/tap directly off the main supply line.
- The check valve/non-return valve is installed backwards.
- The pump is not operating.
- The timer is not operating properly.

### Signs of Dry Run

Dry run results from inadequate water supply to the pump, which prevents lubrication of the bearing ball. It may be caused by operating the pump without water in the plumbing lines, which may occur with frozen pipes, or by failing to turn the pump off when the system is drained for servicing. It can also occur as the result of large air bubbles collecting in the pump housing and preventing the flow of water over the bearing ball. If the problem is air in the system, check that the air vent is functioning, that the system is properly purged of air and that the pump and various system components are installed.

## Safety Requirements

### Mechanical Safety



**WARNING: - Excessive System Pressure Hazard -** The maximum working pressure of the pump is listed on the nameplate - **Do Not Exceed This Pressure.** Failure to follow these instructions could result in serious personal injury, death and/or property damage.



**WARNING: - Excessive Pressure Hazard Volumetric Expansion** - The heating of water and other fluids causes volumetric expansion. The associated forces may cause failure of system components and the release of high temperature fluids. This can be prevented by installing properly sized and located compression tanks and pressure relief valves. Failure to follow these instructions could result in serious personal injury, death and/or property damage.

### Thermal Safety



**WARNING: - Extreme Temperature Hazard** - If the pump, motor or piping are operating at extremely high or low temperature, guarding or insulation is required. Failure to follow these instructions could result in serious personal injury, death and/or property damage.

### Electrical Safety



**WARNING: - Electrical Shock Hazard** - Electrical connections are to be made by a qualified electrician in accordance with all applicable codes, ordinances and good practices. Failure to follow these instructions could result in serious personal injury, death and/or property damage.



**WARNING: - Electrical Grounding Hazard** - Adequate electrical grounding is required for the safe operation of B&G Pumps. Ground the pump back to the service using a copper conductor at least the size of the circuit connectors supplying the pump. Connect the ground wire to the ground terminal in the wiring compartment. Failure to follow these instructions could result in serious personal injury, death and/or property damage.



**WARNING: - Risk of Electric Shock** - Do not install this pump in swimming pool or marine areas. Failure to follow these instructions could result in serious personal injury, death and/or property damage.

### Removal of Pump From Existing System For Replacement



**WARNING: - Electrical Shock Hazard** - Disconnect and lockout the power before servicing. Failure to follow these instructions could result in serious personal injury, death and/or property damage.

1. Close the valves on the suction and discharge sides of the pump. (if no valves have been installed, it may be necessary to drain the system.)
2. Disconnect the electrical supply lines to the pump.



**WARNING: - Hot Water Hazard** - Before draining the system, allow water to cool to at least 100F, open the drain valve (take precautions against water damage) and leave the drain valve open until servicing is complete. Failure to follow these instructions could result in serious personal injury, death and/or property damage.



**WARNING: - Electrical Shock Hazard** - Be certain the electrical power is not present at the motor leads before continuing. Failure to follow these instructions could result in serious personal injury, death and/or property damage.



**WARNING: - High Pressure Hazard** - Pressure may be present in the pump body. This pressure can be relieved by loosening the flange bolts and shifting the pump assembly slightly to allow the pressurized water to escape. Failure to follow these instructions could result in serious personal injury and death.



Xylem Inc.  
8200 N. Austin Avenue  
Morton Grove, Illinois 60053  
Phone: (847) 966-3700  
Fax: (847) 965-8379  
[www.xylem.com/brands/bellgossett](http://www.xylem.com/brands/bellgossett)